

Price list

UK & Ireland. GBP – Valid from 01.01.2018

HAG

Celebrating movement



Content

General Terms & Conditions	4
HÅG SoFi®	6
HÅG Capisco®	8
HÅG Capisco Puls®	9
HÅG Futu®	10
HÅG Executive	12
HÅG H05®	17
HÅG H04®	20
HÅG H03®	22
HÅG Conventio®	23
HÅG Conventio Wing®	25
HÅG Accessories	27
Main Spare Parts	28
Physical Measurements	34
Tests and Certificates	38
HÅG Fast	40
HÅG Total Colour Extended Collection	41
HÅG Colour and Fabrics	43
HÅG Total Colour Standard Collection	45

General Terms and Conditions

Standard delivery times

Standard dispatch times from factory	Working days
HÅG Fast (after order has been registered)	5-10
HÅG Total Colour Standard	10-15
HÅG Total Colour Extended	20-25*
Special and COM	on request
Transport-days must be added.	

* Provided the supplier has the fabric in stock.
Longer delivery times may occur periodically, during holidays and for large orders.

Order Entry Specifications

When placing your order please remember to specify the following information:

- Chair model
- Number of chairs
- Fabric/Leather and Colour Code
- Plastic colour on HÅG Conventio Wing
- Plastic colour on HÅG Capisco Puls
- Colour of base
- Type of castors or glides
- Delivery date
- Delivery address

Colour on base

Where a base is specified in black, other metal components will also be in black. Similarly, chairs on silver bases have metal components in silver. Other metal colours need to be specified for chairs with polished aluminium bases (extra cost option). Specified combinations are defined for:

HÅG SoFi
HÅG Executive
HÅG H05 Communication

Castors

Both hard and soft castors and glides are supplied according to EN1335 Class A standard, and must be specified at time of order (soft for hard flooring, hard for soft flooring). Additional castor options are available on request, but must be specified at time of order and the delivery lead time may be increased. Price on application.

Prices

All prices are shown in GBP and exclude VAT. Any typographical errors shall not be binding for Flokk and will be subject to correction without liability to the vendor.

Conditions of Delivery

Ex Works (Incoterms 2010), including packaging.

If the goods arrive damaged, the recipient/customer must inform the supplier within 48 hours of receipt.

Packaging material - recycling

We encourage you to ensure recycling of all packaging material. Please sort and return the packaging material, using your local recycling partners/stations - and follow your local regulations.

If you have questions on how to handle waste packaging material, please inform your contact person within Flokk.

HÅG Warranty

General terms and conditions

Flokk's warranty covers all HÅG chairs against material and manufacturing faults and defects from the chair's production date. The warranty covers any necessary spare parts. Labour and transport costs are not covered. Wear and tear must be expected from normal use and are not covered by the warranty. Unless otherwise specified, the maximum weight for users is 110 kg. The warranty is conditional on the chair and fabrics/leather undergoing normal cleaning. The guarantee does not cover the consequence of wear and stains when choosing a light (white) colour for plastic or metal components.

10 year warranty for HÅG products

Flokk provides a 10 year warranty for all HÅG chairs that are in normal use for up to 9 hours per day. Please also see the general warranty terms and conditions.

24/7 – 5 year warranty

Flokk provides a 5 year warranty for HÅG chairs that are specifically purchased for 24 hour use and which are upholstered in 24/7 approved fabrics/leather from Flokk's Standard Fabric collection. Please also see the general warranty terms and conditions.

>9 hours/day – 5 year warranty

Flokk provides a 5 year warranty for all HÅG chairs that are in normal use for more than 9 hours per day. Please also see the general warranty terms and conditions.

Spare parts guarantee

Flokk guarantees the delivery of spare parts for a minimum of 10 years after the chair's production date. The guarantee covers the parts necessary to maintain the chair's original functionality.

HÅG Total Colour (HTC) collection

HÅG Total Colour (HTC) Standard fabric/colour collection

Flokk provides a 10 year warranty for fabrics/leather from the HTC Standard collection when the chair is in normal use for up to 9 hours per day. Flokk provides a 5 year warranty for fabrics/ leather from the HTC Standard collection when the chair is in normal use for more than 9 hours per day.

HÅG Total Colour (HTC) Extended fabric/colour collection

Flokk provides a 5 year warranty for fabrics/leather from the HTC Extended collection when the chair is in normal use for up to 9 hours per day. Some of the fabrics in the HTC Extended collection are available with a 5 year warranty for 24 hour use (for use of more than 9 hours per day).

Special or Customer specified fabrics/leather

If the fabrics in the HÅG Total Colour (HTC) Standard or Extended collections are not what you are looking for, please contact Customer Service at Flokk, email: info-uk@flokk.com. The general warranty terms and conditions cover the chair against material and manufacturing faults, but not the upholstery. This does not affect your rights and obligations under local law. Customer specified fabrics/leather can only be used following approval by Flokk.

Approvals and Certifications

Flokk is ISO 9001 accredited. The German test institutes, LGA and Intertek, have approved and issued the GS certificate (Geprüfte Sicherheit) for a number of HÅG products.

- HÅG task chairs are tested in accordance with both EN 1335 Type A (European office chair standard) and ANSI Bifma (American standard).
- HÅG conference and visitor chairs are tested in accordance with EN 13761, EN 16139 and the ANSI Bifma standard.
- HÅG SoFi, HÅG Futu, HÅG H04, HÅG H05 and HÅG Executive are tested according to British Standard BS 5459-2, a commonly used standard for intensive use (24 hours).

EN 1335 is a European Standard for office chairs and considers dimensions of the chair, safety requirements and safety test methods. The European Standard tests are based on 8 hours daily use by persons weighing up to 110 kg (17.3 stone).

The British Standard (BS 5459-2) tests that the chair will be suitable for more than 8 hours daily use and for persons weighing up to 150 kg (23.6 stone).

The majority of HÅG products are tested and approved according to the Swedish Möbelfakta requirements.

ESD (Electro Static Discharge)

We can supply HÅG H04 4100, HÅG H05 5400, HÅG Capisco Puls 8001, 8010 and HÅG Capisco 8106 as ESD chairs upholstered in anti-static synthetic leather (Nevotex) or Global ESD (Bogesunds) in price group 6 +10%. For HÅG Capisco Puls the price will be price group 5 + 25%. Flokk provides a 5 year warranty on ESD chairs, conditional on castors and upholstery being cleaned regularly with a suitable cleaning agent.

Cleanroom

We can supply HÅG models with vinyl that are suitable for areas that need to be cleaned. Please contact Customer Service for further information.

HÅG Capisco Puls 8010 upholstered in anti-static synthetic leather by Nevotex (price group 3) approves an air cleanliness test according to ISO 14644, class 4-5. Flokk provides a 5 year warranty on cleanroom chairs, conditional on castors and upholstery being cleaned regularly with a suitable cleaning agent.

Maintenance guide

Care of fabric upholstery:

Regular vacuum cleaning is recommended. Vacuum clean the chair with a furniture brush or wipe it with a clean white cloth or sponge slightly dampened with lukewarm, clean water. Marks and stains should be removed with a proprietary cleaner.

Care of leather upholstery:

Wipe with a slightly damp cloth and gently rub dry. A good proprietary hide food should be applied at least once a year and more often if the leather is in a dry atmosphere or close to a heat-source.

Do not remove any plastic parts or attempt to open the seating mechanism.

For additional maintenance advice please contact our customer service team.

End of life - Recycling

We encourage you to ensure recycling of your chair and its various components, according to the 'end of life matrix' described in your chair's user manual. Please dispose of your chair/components using your local recycling partners/stations - and follow your local regulations.

If you have questions on how to dispose or return your chair after use, please inform your contact person within Flokk.

Fire resistant foam

Fire resistant foam is available on request, but must be specified at time of order and adds approximately two to five weeks to delivery lead times. Price on request. CMHR foam must be specified on chairs intended for domestic use.

Change/cancellation of orders

Change/cancellation of orders on chairs or upholsteries is possible up until production has begun. Each amended or cancelled order will incur a charge of £50 per order. Once production has started orders cannot be changed. Change of orders within the HÅG Fast collection are not possible.

For further information regarding change /cancellation of orders, please feel free to contact our Customer Service department.



Customer Service

Flokk
Phone: 020 8683 9930
E-mail: info-uk@flokk.com

Flokk reserves the right to make small construction alterations without notice.

HÅG SoFi® – Task chairs

- HÅG in Balance® (balanced, flowing tilt function backwards and forwards)
- Seat depth adjustment
- Seat height adjustment
- Adjustable lumbar support
- Adjustable tilting resistance forwards and backwards
- Lockable tilt
- Five star aluminum base (730mm) available in black, silver or white, optionally in polished aluminium. Mechanism cover is black when ordering black base. It's light grey when ordering silver or white base. Please specify when placing your order
- Castors for hard or soft flooring. Must be specified at time of order
- 200 mm lift (Seat height: 450-640mm)
- Painted aluminum colours: black, silver or white
- Plastic colours: black or light grey



Item no	Base model +	Price Group (PG)	①	②	③	④	⑤	⑥	Price
7500	HÅG SoFi 7500 • Mesh back. The mesh back comes in black (MEH001) or grey (MEH002) and matches the frame colour. • High back		558	561	580	604	626	699	
7200	HÅG SoFi 7200 • Medium back		577	582	600	623	646	722	
7300	HÅG SoFi 7300 • High back		611	617	636	661	685	766	
Accessories/Options									
	Headrest		193	196	202	210	217	252	
	Adjustable armrests in plastic with soft tops (width 92 mm) and stem in painted aluminium								133
	- Surcharge for armrests in painted aluminium with soft tops (102 mm) and stem in aluminium								24
	- Surcharge for armrests in black plastic with soft tops (width 92 mm) and stem in polished aluminium								52
	- Surcharge for armrests in polished aluminium with soft tops (width 102 mm) and stem in polished aluminium								79
	- Surcharge for armrests with HÅG SlideBack								31
	- Surcharge for armrests with leather tops, black or dark grey (For armrest in aluminium)								54
	- Surcharge for armrests with 3D tops (for armrest in plastic)								31
	165 mm lift								- 5
	HÅG FootRing**								92
	Footbase (Ø730 mm) in polished aluminium								70
	Decorative stitching*								57

* Available for all models, but only for seat on HÅG SoFi with mesh back. Please see HÅG Colour and Fabrics for additional information.

** Must be ordered together with 200 mm lift.

HÅG SoFi® – Communication chairs

- HÅG in Balance® (balanced, flowing tilt function backwards and forwards)
- Seat depth adjustment
- Seat height adjustment
- Lumbar support
- 4 star base in aluminium (Ø785 mm), black, silver or white, optionally in polished aluminium. Mechanism cover is black when ordering black base and light grey when ordering silver or white base. Please specify when placing your order
- Plastic glides for soft flooring or felt glides for hard flooring. Must be specified at time of order
- 165 mm lift (Seat height: 400-550 mm)
- Painted aluminum colours: black, silver or white
- Plastic colour: black or light grey

Item no	Base model +	Price Group (PG)	①	②	③	④	⑤	⑥	Price
7502	HÅG SoFi Communication 7502 <ul style="list-style-type: none"> • Mesh back. The mesh back comes in black or grey and matches the frame colour. • High Back 		441	444	458	477	495	557	
7202	HÅG SoFi Communication 7202 <ul style="list-style-type: none"> • Medium back 		483	489	503	523	542	606	
7302	HÅG SoFi Communication 7302 <ul style="list-style-type: none"> • High back 		520	526	542	563	584	652	





Accessories/Options

Adjustable armrests in plastic with soft tops (width 92 mm) and stem in painted aluminium	133
- Surcharge for armrests in painted aluminium with soft tops (102 mm) and stem in aluminium	24
- Surcharge for armrests in black plastic with soft tops (width 92 mm) and stem in polished aluminium	52
- Surcharge for armrests in polished aluminium with soft tops (width 102 mm) and stem in polished aluminium	79
- Surcharge for armrests with leather tops, black or dark grey (For armrest in aluminium)	54
Four star base (Ø785 mm) in polished aluminium	70
Five star base (Ø730 mm) in polished aluminium with castors (as for task chair)	70
Decorative stitching*	57
200 mm lift (Only for: 7202, 7302)	5

* Available for all models, but only for seat on HÅG SoFi with mesh back. Please see HÅG Colour and Fabrics for additional information.

HÅG Capisco® - Task chairs

- HÅG in Balance® (balanced, flowing tilt function)
- Adjustable tilt tension backwards (not available for 8105)
- Seat height adjustment
- Seat depth adjustment (not available for 8105)
- Back height adjustment (not available for 8105)
- Lockable seat (not available for 8105)
- Suitable for all working surfaces with table height of 72 cm and higher
- Five star base in aluminium (Ø730 mm) with curved/arched footplates, black, silver or white, optionally in polished aluminium (see options below). Please specify colour at time of order
- 200 mm lift (Seat height: 470-655 mm). 265 mm lift standard for 8105 (Seat height: 570-810 mm)

Item no	Base model +	Price Group (PG)	①	②	③	④	⑤	⑥	Price
8105	HÅG Capisco 8105		285	288	298	309	327	344	
8106	HÅG Capisco 8106 • Available as electro static discharged (ESD) chair (PG 6 + 10%)		723	731	753	782	826	869	
8107	HÅG Capisco 8107 • Headrest (only available in silver and black)		849	857	883	917	969	1 020	
8126	HÅG Capisco 8126		723	731	753	782	826	869	
8127	HÅG Capisco 8127 • Headrest (only available in silver and black)		849	857	883	917	969	1 020	

Accessories/Options





150 mm lift	0
265 mm lift (glides are recommended, no additional charge)	11
Telescopic lift cover	6
Five star base (Ø730 mm) in polished aluminium	84
Decorative stitching*	57
HÅG StepUp	99
HÅG FootRing**	92

* Available for model 8105, 8106 and 8107. Please see HÅG Colour and Fabrics for additional information.

** Must be ordered together with 200 or 265 mm lift

HÅG Capisco Puls® - Task chairs

- HÅG in Balance® (balanced, flowing tilt function)
- Adjustable tilt tension backwards (not available for 8001 and 8002)
- Seat height adjustment
- Seat depth adjustment (not available for 8001 and 8002)
- Back height adjustment (not available for 8001 and 8002)
- Lockable seat (not available for 8001 and 8002)
- Seat and backrest available in 8 different colours: Clay, Pink, Sea Green, Petroleum, Light Grey, Black, White and Red. Please specify colour at time of order
- Five star base (Ø730 mm) in aluminium with curved/arched footplates, black, silver or white, optionally in polished aluminium or black plastic base (Ø700 mm). Please specify colour at time of order

Item no	Base model +	Price Group (PG)	①	②	③	④	⑤	Price
8001	HÅG Capisco Puls 8001 <ul style="list-style-type: none"> • Pad available in all HTC Standard fabrics and leather*** • Seat height: 540-770 mm • 265 mm lift • Available as electro static discharged (ESD) chair (PG 5 + 25 %) 		210	212	218	226	239	
8002	HÅG Capisco Puls 8002 <ul style="list-style-type: none"> • Removable seat cushion in Nexus, Sprint or Evida* • Seat height: 555-785 mm • 265 mm lift 					297	306	
8010	HÅG Capisco Puls 8010 <ul style="list-style-type: none"> • Available for Cleanroom upholstered in Antistatic synthetic leather • Pad available in all HTC Standards and leather*** • Seat height: 455-620 mm • 200 mm lift • Available as electro static discharged (ESD) chair (PG 5 + 25 %) 		296	299	307	319	337	
8020	HÅG Capisco Puls 8020 <ul style="list-style-type: none"> • Removable seat cushion in Nexus, Sprint or Evida* • Seat height: 470-635 mm • 200 mm lift 					350	363	

Accessories/Options

150 mm lift	0
265 mm lift (glides are recommended, no additional charge)	11
Telescopic lift cover	6
Five star base (Ø730 mm) in polished aluminium	84
Five star base (Ø700 mm) in black plastic	- 30
HÅG FootRing**	92
HÅG StepUp	99

* Removable seat cushion for HÅG Capisco Puls 8002 and 8020 are only available in the following fabrics: Nexus and Sprint (Camira) or: Evida (skai by Hornschuch). Nexus and Sprint (Standard colours) and Evida (Extended colours) are price group 3. Nexus and Sprint in Extended colours are price group 4.

** Must be ordered together with 200 or 265 mm lift

*** Pad available in all HTC Standard fabrics except Steelcut Trio and Paloma Soft (leather)

HÅG Futu® - Task chairs

- HÅG in Balance® (balanced, flowing tilt function backwards and forwards)
- Seat depth adjustment
- Adjustable lumbar support
- Seat height adjustment
- Adjustable forwards and backwards tilting resistance
- Lockable tilt
- Aluminium five star base (Ø730 mm) with foot supports, black or silver
- 165 mm lift (Seat height: 400-550 mm)
- Painted aluminum colours: black or silver
- Plastic colours: black

Item no	Base model +	Price Group (PG)							Price
1020-F	HÅG Futu 1020-F • FutuKnit on seat and face of backrest								534
			①	②	③	④	⑤	⑥	Price
1020	HÅG Futu 1020 • Black or grey Futuknit only on face of backrest. HTC Standard on seat		553	560	577	599	622	694	



Accessories/Options

Adjustable armrests, black plastic	48
- Surcharge for armrests with black leather tops	93
- Surcharge for armrests with 3D tops	45
200 mm lift	5
Five star base (Ø680 mm) in black plastic	- 31
HÅG FootRing**	92

** Must be ordered together with 200 mm lift

HÅG Futu® Communication

- Backward tilt
- Sledge base in steel (Seat height: 465 mm)
- Stackable (4 chairs)
- Painted aluminum colours: black or silver
- Plastic colours: black

Item no	Base model +	Price Group (PG)							Price
1070-F	HÅG Futu Communication 1070-F • FutuKnit								242
			①	②	③	④	⑤	⑥	Price
1070	HÅG Futu Communication 1070 • Black or grey FutuKnit on backrest front and HTC Standard on seat		261	263	271	282	298	326	

FutuKnit™ by Camira

FutuKnit is a fabric especially designed for the HÅG Futu precisely shaped and fitted for the back support and seat cushion. The 3D knitted fabric adjusts itself to the curvature of the body. It provides higher seating comfort through soft upholstery with no foam and no unnecessary seams and good resilient elasticity. Eight attractive and harmonic FutuKnit colours are available for the seat and back. (Please have a look and further information below). Otherwise you can select the seat fabric from the complete HÅG Total Colour program in combination with the back in black (FTU001) or grey (FTU002) FutuKnit. For further information please contact your HÅG dealer.

Composition:	100% polyester
Flammability:	BS EN 1021 – 1-2: 2006 (Cigarette & match), BS7176: 2007 Low Hazard
Fastness to rubbing:	Dry and Wet 4 (scale 1–5)
Weight (g/m ²):	Back: 766, Seat: 668
Abrasion:	>110 000 Martindale
Light fastness:	6 (scale 1–8)
Pilling:	5 (BS EN ISO 12945-2)
Maintenance:	To be vacuumed with a furniture brush or use a clean white damp cloth or sponge slightly dampened with clean lukewarm water.
Environmental facts:	Manufacturing process - fully compliant with ISO 14001. EU Ecolabel, Oeko-tex 100.





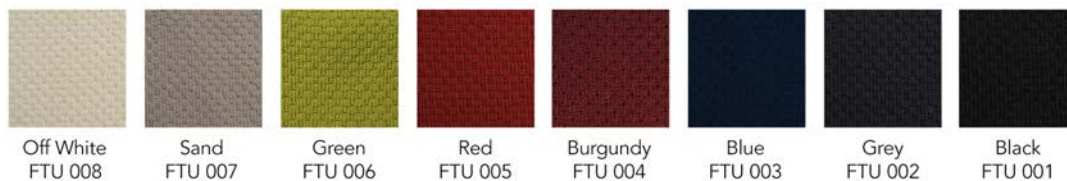

Guarantee:

Flokk offers a 10 year guarantee against material defects and manufacturing faults from date of production on all chairs upholstered in FutuKnit and HTC Standard fabrics and leather.



HÅG® Executive - Task chairs

- HÅG in Balance® (balanced, flowing tilt function backwards and forwards)
- Adjustable forwards and backwards tilt resistance
- Seat height adjustment
- Seat depth adjustment
- Adjustable lumbar support on all models
- Adjustable headrest on model 9031, 9231 and 9331
- Tilt lockable in three positions
- HÅG TiltDown™ armrests (tilt down, height and width) with black leather top
- Five star base (Ø740 mm) with sloping footplates, in matt black aluminium
- All aluminium components are standard black. Optionally available in combinations of polished aluminium or all polished. Please specify colour at time of order. See page 15 for specifications
- 150 mm lift (Seat height: 397-525 mm)



Item no	Base model +	Price Group (PG)	①	②	③	④	⑤	⑥	Price
9031	HÅG Tribute 9031 • Headrest		1 286	1 314	1 360	1 414	1 466	1 629	
9021	HÅG Tribute 9021		1 084	1 108	1 147	1 192	1 236	1 373	
9221	HÅG Inspiration 9221 • Back in Space (dark) or Lumina (black) • Seat and cushion available in Note, Shimmer (PG 4) and Paloma Soft (PG 6)						1 224	1 446	
9231	HÅG Inspiration 9231 • Back with headrest in Space (dark) or Lumina (black) • Seat and cushions available in Note, Shimmer (PG 4) and Paloma Soft (PG 6)						1 383	1 734	
9321	HÅG Excellence 9321 • Rear of backrest is upholstered in black Plaintech • Seat and back available in Vadal Uni (PG 4) and Paloma Soft (PG 6)						1 414	1 734	
9331	HÅG Excellence 9331 • Back with headrest • Rear of backrest is upholstered in black Plaintech • Seat and back available in Vadal Uni (PG 4) and Paloma Soft (PG 6)						1 636	2 031	

Accessories/Options

All polished aluminium	100
Mix of black / polished aluminium - Black foot base with polished details	27
Mix of polished / black aluminium - Polished foot base with black details	85
HÅG Executive Basic armrests (with height and width adjustment)	- 100
200 mm lift	9
Five star base (Ø740 mm), in polished aluminium	73

HÅG® Executive - Meeting chairs

- HÅG in Balance® (balanced, flowing tilt function backwards and forwards)
- Seat height adjustment
- Adjustable back cushion (lumbar)
- Swivel
- Adjustable tilting resistance backwards
- Five star base (Ø650 mm) with sloping footplates, in matt black aluminium
- All aluminium components are standard black. Optionally available in combinations of polished aluminium or all polished. Please specify colour at time for order. See page 15 for specifications
- 150 mm lift (Seat height: 385-520 mm)

Item no	Base model +	Price Group (PG)	①	②	③	④	⑤	⑥	Price
9073	HÅG Tribute Meeting 9073		782	799	827	860	891	1 025	
9273	HÅG Inspiration Meeting 9273 <ul style="list-style-type: none"> • Back in Space (dark) or Lumina (black). • Seat and cushion available in Note, Shimmer (PG 4) and Paloma Soft (PG 6) 					717		927	
9373	HÅG Excellence Meeting 9373 <ul style="list-style-type: none"> • Rear of backrest is upholstered in black Plaintech • Seat and back available in Vadal Uni (PG 4) and Paloma Soft (PG 6) 					923		1 149	

Accessories/Options

All polished aluminium	100
Mix of black / polished aluminium - Black foot base with polished details	27
Mix of polished / black aluminium - Polished foot base with black details	85
HÅG Executive Basic armrests (with height and width adjustment)	157
Five star base (Ø650 mm) in polished aluminium	76
Four star base (Ø785 mm) in black painted aluminium	- 29
Four star base (Ø785 mm) in polished aluminium	43

HÅG EXECUTIVE COLLECTION – ADDITIONAL INFORMATION

We offer 4 predefined configurations for the HÅG Executive range:



HÅG Tribute 9031

ALL BLACK (standard)

- Black aluminium foot base – 1
- Black lift cover – 2
- Black armrests – 3
- Black lower part of armrests – 4
- Black lumbar wheel – 5
- Black ring/cover for lumbar wheel – 6
- Black Headrest stem cover – 8
- Black headrest stem – 7
- Black spine – 9
- Black upper and lower back bars – 10



HÅG Excellence 9321



HÅG Tribute 9031

BLACK FOOTBASE WITH POLISHED DETAILS (option)

- Black aluminium foot base – 1
- Polished lift cover – 2
- Polished armrests – 3
- Polished ring/cover for lumbar wheel – 6
- Polished headrest stem cover – 8
- Black lower part of armrests – 4
- Black lumbar wheel – 5
- Black headrest stem – 7
- Black spine – 9
- Black upper and lower back bars – 10



HÅG Excellence 9321



HÅG Tribute 9031

POLISHED FOOTBASE WITH DETAILS IN BLACK (option)

- Polished aluminium foot base – 1
- Black lift cover – 2
- Black lower part of armrests – 4
- Black lumbar wheel – 5
- Black headrest stem cover – 8
- Black spine – 9
- Polished armrests – 3
- Polished ring/cover for lumbar wheel – 6
- Polished headrest stem – 7
- Polished upper and lower back bars – 10



HÅG Inspiration 9221



HÅG Tribute 9031

ALL POLISHED (option)

- Polished aluminium foot base – 1
- Polished lift cover – 2
- Polished armrests – 3
- Polished lumbar wheel – 5
- Polished ring/cover for lumbar wheel – 6
- Polished Headrest stem cover – 8
- Polished Headrest stem – 7
- Polished upper and lower back bars – 10
- Black lower part of armrests – 4
- Black spine – 9



HÅG Inspiration 9221

HÅG EXECUTIVE ADDITIONAL INFORMATION – FABRICS

PLAINTECH (SR-WEBATEX)

(used on the rear side of the backrest on HÅG Excellence 9321 and 9331 and HÅG Meeting Excellence 9373)

Composition: 100 % polyamide
Flammability: BS EN 1021: 1–2 (Cigarette & match)

Space (dark) (Gabriel) and Lumina (K&R Sax)
(used on the back of HÅG Inspiration 9221 and 9231 and HÅG Meeting Inspiration 9273). These innovative textiles are self-supportive, which gives new possibilities regarding product design as well as becoming an important part of the sitting experience.

SPACE

Composition: 100 % polyester monofilament
Abrasion and tear-strength: 2469N x 11083N support strength
Flammability: BS EN 1021: 1–2 (Cigarette & match), FAR 25.853, DIN 4104 - B1 and B2, BS 5852 P 2 crib5
Environmental facts: ISO 14001 certified
Colour:

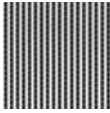

Space
SPA 000

LUMINA

Composition: 67% polyester, 33% polyamide
Abrasion: >100 000 Martindale
Tear-strength: 1457N x 1283N
Flammability: BS EN 1021: 2006 (Cigarette)
Environmental facts: ISO 14001 certified
Colour:

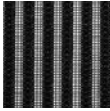

Black Lumina
LUM 100









For all the above mentioned fabrics the following guarantee and maintenance apply:

Guarantee: 10 years, 5 years for 24/7 use.

Maintenance: To be vacuumed with a furniture brush, wiped with a clean damp cloth or sponge slightly dampened with clean lukewarm water.

HÅG H05® - Task chairs

- HÅG in Balance® (balanced, flowing tilt function backwards and forwards)
- 4 in 1 adjustment: seat depth, back height and forward and backward tilt tension in one wheel
- Adjustable seat height
- Possibility to adjust backrest separately
- Lockable in three positions
- Five star base (Ø730 mm) in aluminium with curved/arched footplates, standard in black or silver, optionally in polished aluminium.
Please specify colour at time of order
- 150 mm lift (Seat height: 390-515 mm)

Item no	Base model +	Price Group (PG)	①	②	③	④	⑤	⑥	Price
5100	HÅG H05 5100 • Partially upholstered • Low back		462	467	480	499	527	579	
5200	HÅG H05 5200 • Fully upholstered • Low back		501	506	522	542	572	628	
5300	HÅG H05 5300 • Partially upholstered • Medium back		564	569	587	609	644	706	
5400	HÅG H05 5400 • Fully upholstered • Medium back • Available as electro static discharged (ESD) chair. (PG 6 + 10%) • Headrest and armrests not available for ESD chair		612	620	637	663	699	768	
5500	HÅG H05 5500 • Partially upholstered • High back		604	609	628	652	690	755	
5600	HÅG H05 5600 • Fully upholstered • High back		646	652	672	698	737	809	

Accessories/Options



Headrest HÅG H05 5100, 5300, 5500	182	184	190	197	204	234	
Headrest HÅG H05 5200, 5400, 5600	202	203	209	217	226	259	
Adjustable armrest							105
- Surcharge for armrests with leather tops (black standard)							99
- Surcharge for armrests with 3D tops							47
- Surcharge for HÅG SwingBack® armrests							71
200 mm lift							4
265 mm lift (glides are recommended, no additional charge)							14
Five star base (Ø730 mm) in polished aluminium							84
Decorative stitching*							57
HÅG StepUp							99
HÅG FootRing**							92

* Available for model 5200, 5400 and 5600. Please see HÅG Colour and Fabrics for additional information

** Must be ordered together with 200 or 265 mm lift





HÅG H05® Communication

- HÅG in Balance® (balanced, flowing tilt function backwards and forwards)
- Medium back
- Legs in aluminium, black or silver, optionally in polished aluminium. Please specify colour at time of order (Seat height: 445 mm)
- Glides for hard or soft flooring need to be specified at time of order

Item no	Base model +	Price Group (PG)	①	②	③	④	⑤	⑥	Price
5370	HÅG H05 5370 • Partially upholstered • Plastic glides		311	316	325	338	350	391	
5470	HÅG H05 5470 • Fully upholstered • Plastic glides		355	360	371	385	400	446	
Accessories/Options									
Armrests HÅG H05 Comm. 5370, 5470, black									29
Polished legs									117

HÅG H04® - Task chairs



- HÅG in Balance® (balanced, flowing tilt function backwards and forwards)
- Seat depth adjustment
- Back height adjustment
- Adjustable seat height
- Adjustable tilt tension forwards and backwards
- Lockable in three positions
- Five star base (Ø730 mm) in aluminium with footplates, standard in black or silver, optionally in polished aluminium. Please specify colour at time of order
- 150 mm lift (Seat height: 395-530 mm)

Item no	Base model +	Price Group (PG)	①	②	③	④	⑤	⑥	Price
4100	HÅG H04 4100 <ul style="list-style-type: none"> • Low back • Smaller seat than 4200 (5 mm width and 10 mm depth) • Available as electro static discharged (ESD) chair (PG 6 + 10%) • Headrest and armrests not available for ESD chair 		477	483	497	517	545	598	
4200	HÅG H04 4200 <ul style="list-style-type: none"> • Low back 		503	509	524	544	575	631	
4400	HÅG H04 4400 <ul style="list-style-type: none"> • Medium back 		608	614	633	657	694	762	
4600	HÅG H04 4600 <ul style="list-style-type: none"> • High back 		639	645	665	691	729	800	
4650	HÅG H04 4650 <ul style="list-style-type: none"> • Extra wide (40 mm wider than 4600) 		691	697	717	745	787	864	
Accessories/Options									
Headrest HÅG H04 4400, 4600, 4650			211	214	218	228	236	270	
Adjustable armrests									80
- Surcharge for armrests with leather tops (black standard)									62
- Surcharge for armrests with 3D tops									73
200 mm lift									4
265 mm lift (glides are recommended, no additional charge)*									14
Five star base (Ø730 mm) in polished aluminium									84
HÅG FootRing**									92
HÅG StepUp									99

** Must be ordered together with 200 or 265 mm lift

HÅG H04® Communication

- HÅG in Balance® (balanced, flowing tilt function backwards and forwards)
- Glides for hard or soft flooring need to be specified at time of order



Item no	Base model +	Price Group (PG)	①	②	③	④	⑤	⑥	Price
4470	HÅG H04 4470 • Sledge base in steel: black or silver (Seat height: 445 mm)		356	360	370	385	406	446	
4472	HÅG H04 4472 • Adjustable seat height • Aluminium 5 star base (Ø730 mm) w/footplates: black or silver • 150 mm lift (Seat height: 375-515 mm)		374	377	390	404	427	468	

Accessories/Options

Armrests in aluminium. Silver or black.

HÅG H03® - Task chairs

- HÅG in Balance® (balanced, flowing tilt function backwards and forwards)
- Seat height adjustment
- Combined adjustment of back height and seat depth
- Five star base (Ø686 mm) in plastic with sloping footplates
- 150 mm lift (Seat height: 412-551 mm)

Item no	Base model +	Price Group (PG)	①	②	③	④	⑤	⑥	Price
330	HÅG H03 330 <ul style="list-style-type: none"> • Low back • Removable upholstery on seat and back (low) • Back bar and arm slides in black or silver 		358	361	371	386	407	448	
340	HÅG H03 340 <ul style="list-style-type: none"> • Removable upholstery on seat and back (medium) • Individual tilt tension adjustment 		389	393	405	420	444	487	
350	HÅG H03 350 <ul style="list-style-type: none"> • Fully upholstered seat and back (medium) • Individual tilt tension adjustment 		460	466	479	498	526	578	

Accessories/Options

Adjustable armrests	58
200 mm lift	4
265 mm lift (glides are recommended, no additional charge)*	14
Telescopic lift cover	6
Five star base (Ø730 mm) in aluminium - silver/black	29
Five star base (Ø730 mm) in polished aluminium	84
HÅG FootRing**	92

*265 mm lift must be ordered together with five star base in aluminium







** Must be ordered together with 200 or 265 mm lift

HÅG Conventio® - conference chairs

- HÅG in Balance® (balanced, flowing tilt function backwards and forwards)
- Black or silver coloured backstems, must be specified at time of order for models 9512 and 9522

The following applies for models 9510, 9511, 9520 and 9521:

- Legs in black or silver aluminium. Please specify colour at time of order
- Stackable (15 chairs), only available for 4 legged models
- Glides for hard or soft flooring need to be specified at time of order

Item no	Base model +	Price Group (PG)	①	②	③	④	⑤	⑥	Price
9510	HÅG Conventio 9510 ● Upholstered seat and backrest front (plastic back) ● Removable upholstery ● Built-in handle for carrying ● Seat height: 455 mm		231	233	240	250	263	289	
9511	HÅG Conventio 9511 ● As 9510 above ● 4 cm wider than 9510 ● Seat height: 450 mm		253	256	263	273	288	317	
9512	HÅG Conventio 9512 ● 5 star plastic foot base (Ø635 mm) ● 150 mm lift (Seat height: 400-540 mm) ● Backstems in black or silver		271	274	283	294	309	340	
9520	HÅG Conventio 9520 ● Upholstered seat and back ● Removable upholstery ● Seat height: 455 mm		237	239	247	256	271	297	
9521	HÅG Conventio 9521 ● As 9520 above ● 4 cm wider than 9520 ● Seat height: 450 mm		263	265	273	284	300	329	
9522	HÅG Conventio 9522 ● 5 star plastic foot base (Ø635 mm) ● 150 mm lift (Seat height: 400-540 mm) ● Backstems in black or silver		280	283	291	302	320	350	

Accessories/Options

	Armrest in plastic	39
165240	HÅG Writing tablet. Black, right-handed. Fold down tablet for storage and stacking of chair. (Only for: 9510, 9511, 9520, 9521)	55
165242	HÅG Writing tablet. Black, right-handed + Armrest in plastic, left side. (Only for: 9510, 9511, 9520, 9521)	74
	Five star base (Ø730 mm) in aluminium - silver/black (Only for: 9512, 9522)	29
	Five star base (Ø730 mm) in polished aluminium (Only for: 9512, 9522)	113
115805	Chair hanger. Must be specified at time of order. Can not be retrofitted*	33
115806	Chair hanger. Must be specified at time of order. Can not be retrofitted	33
	Connection device - only available for 4 legged models (Only for: 9510, 9511, 9520, 9521)	4
149201	Chair trolley (10 chairs)	224
108984	HÅG SlipCover available in Atlantic (Gabriel) off-white or grey (Only for: 9510, 9520)	65







* For models 9512 and 9522.



108984

HÅG Conventio Wing® - conference chairs

- HÅG in Balance® (balanced, flowing tilt function backwards and forwards)
- 9811, 9821, 9831: 4 legs and backstems in matt black or silver coloured aluminium
- Please specify colour at time of order
- 9812, 9822, 9832: 5 star foot base in black plastic. 150mm gaslift.
- Seat and backrest available in 6 different colours: Clay, Sea Green, Petroleum, Black, White and Red
- Stackable: 15 chairs (4 legged models)
- Glides for hard or soft flooring need to be specified at time of order





Item no	Base model +	Price Group (PG)	①	②	③	④	⑤	⑥	Price
9811	HÅG Conventio Wing 9811 ● Plastic seat and back ● Seat height: 430 mm		141						
9812	HÅG Conventio Wing 9812 ● Plastic seat and back ● 5 star plastic foot base (Ø635 mm) ● Backstems in matt black or silver ● Seat height: 375-515 mm		183						
9821	HÅG Conventio Wing 9821 ● Removable upholstery on seat ● Plastic back ● Seat height: 430 mm		178	180	185	192	202	223	
9822	HÅG Conventio Wing 9822 ● Removable upholstery on seat ● Plastic back ● 5 star plastic foot base (Ø635 mm) ● Backstems in matt black or silver ● Seat height: 380-520 mm		220	222	229	237	251	275	
9831	HÅG Conventio Wing 9831 ● Removable upholstery on seat and back ● Seat height: 430 mm		218	220	226	235	248	273	
9832	HÅG Conventio Wing 9832 ● Removable upholstery on seat and back ● 5 star plastic foot base (Ø635 mm) ● Backstems in matt black or silver ● Seat height: 380-520 mm		259	262	269	281	296	325	

Accessories/Options

	Armrest in plastic	39
165240	HÅG Writing tablet. Black, right-handed. Fold down tablet for storage and stacking of chair. (Only for: 9811, 9821, 9831)	55
165242	HÅG Writing tablet. Black, right-handed + Armrest in plastic, left side. (Only for: 9811, 9821, 9831)	74
	Five star base (Ø730 mm) in aluminium - silver/black (Only for: 9812, 9822, 9832)	29
	Five star base (Ø730 mm) in polished aluminium (Only for: 9812, 9822, 9832)	113
165243	Chair suspension for HÅG Conventio Wing only. To be mounted on the underside of a table top.	20
115805	Chair hanger. Must be specified at time of order. Can not be retrofitted*	33
115806	Chair hanger. Must be specified at time of order. Can not be retrofitted	33
	Connection device - only available for 4 legged models (Only for: 9811, 9821, 9831)	4
149201	Chair trolley (10 chairs)	224

* For models 9812, 9822 and 9832.

HÅG Accessories

Item no	Base model +	Price Group (PG)	Price
165177-1A/2A	<p>HÅG StepUp</p> <ul style="list-style-type: none"> ● Black (1A) or silver (2A) ● Two extra levels for your feet ● Greater variety of seating positions ● Easy to attach and detach ● For use with 150, 200 and 265 mm gas lifts ● Suits desk heights of 80-95 cm 		99
165178-1A/2A	<p>HÅG StepUp</p> <ul style="list-style-type: none"> ● Two pack, black or silver 		190
165134	<p>HÅG QuickStep</p> <ul style="list-style-type: none"> ● Tilting footrest, stimulates circulation ● Foot massager ● Balance training 		114
165129	<p>HÅG QuickStep</p> <ul style="list-style-type: none"> ● Six pack 		619
169121	<p>HÅG FootRing</p> <ul style="list-style-type: none"> ● Black, silver or white ● Additional height for the feet to rest on ● Compatible with all HÅG task chairs (except HÅG H09) with 200 or 265 mm gas lifts 		92
149201	<p>Chair trolley (10 chairs)</p> <ul style="list-style-type: none"> ● Trolley for moving HÅG Conventio and HÅG Conventio Wing with 4 legs only ● Recommended for max 8 pcs ● Black 		224

Main spare parts

Explanation to colour codes:

No colour code specified = Semi matt polyester paint on metal components, or single black plastic parts

1 = Semi matt black polyester paint on metal components

2 = Fine structured silver polyester paint on metal components

3 = Semi matt white polyester paint on metal components

P = Polished metal

P1 = Polished metal and semi matt black polyester painted metal components

1A = Semi matt black polyester paint on metal components and black plastic parts

2A = Fine structured silver polyester paint on metal components and black plastic parts

2D = Fine structured silver polyester paint on metal components and grey plastic parts

3A = Semi matt white polyester paint on metal components and black plastic parts

3D = Semi matt white polyester paint on metal components and grey plastic parts

PA = Polished metal components and black plastic parts

BB = Glossy black polyester paint on metal components and black plastic parts

NB = Anodised metal components (aluminium colour) and black plastic parts

Item no	Gas lifts	Price
143200-1A	A, 150 mm, black	78
143200-2A	A, 150 mm, silver	78
143202-1A	D, 200 mm, black	78
143202-2A	D, 200 mm, silver	78
143202-3	D, 200 mm, white for HÅG Capisco and HÅG Capisco Puls	78
143204-1A	E, 265 mm, black	91
143204-2A	E, 265 mm, silver	91
143204-3	E, 265 mm white	91
143211-1A	165 mm gaslift, black for HÅG SoFi/HÅG Futu	86
143211-2A	165 mm, silver, for HÅG SoFi/HÅG Futu	86
143211-3A	165 mm, white for HÅG SoFi	86
143218-1A	200 mm, black for HÅG SoFi/HÅG Futu	98
143218-2A	200 mm, silver for HÅG SoFi/HÅG Futu	98
143218-3A	200 mm, white for HÅG SoFi	98
143173-1A	200 mm, with black lift cover for HÅG Executive models	88
143173-PA	200 mm, with polished lift cover for HÅG Executive models	90
143172-1A	150 mm, with black lift cover for HÅG Executive models	81
143172-PA	150 mm, with polished lift cover for HÅG Executive models	81
143212-1A	150 mm, with black lift cover for HÅG Executive meeting models	79
143212-PA	150 mm, with polished lift cover for HÅG Executive meeting models	81
143206-1A	150 mm, black, for HÅG H03, HÅG Conventio, HÅG Conventio Wing	63

Item no	Footbases, excluding castors	Price
126154-P	Five star foot base for HÅG Executive models in polished aluminium	191
126158	Five star foot base for HÅG Executive models in matt black aluminium	114
113162	Five star foot base for HÅG Conventio 9512, 9522, HÅG Conventio Wing 9812, 9822, 9832 in black plastic	46
126160-P	Five star foot base for HÅG Executive meeting in polished aluminium	184
126178	Five star foot base for HÅG Executive meeting in matt black aluminium	108
113163	Five star foot base for HÅG H03 in black plastic	46
113016	Five star foot base for HÅG H04/H05/Capisco/Capisco Puls, in black plastic	37
113940	Five star foot base for HÅG Futu in black plastic	45
126164-1A	Four star foot base for HÅG Executive meeting/SoFi Comm., in black alum. w/hard glides for soft floor	79
126164-2A	Four star foot base for HÅG SoFi Comm., in silver aluminium, w/hard glides for soft floor	79
126164-3A	Four star foot base for HÅG SoFi Comm., in white aluminium, w/hard glides for soft floor	79
126165-1A	Four star foot base for HÅG Executive meeting/SoFi Comm., black alum. w/soft glides for hard floors	79
126165-2A	Four star foot base for HÅG SoFi Comm., in silver aluminium, w/soft glides for hard floor	79
126165-3A	Four star foot base for HÅG SoFi Comm., in white aluminium, w/soft glides for hard floor	79
126165-PA	Four star foot base for HÅG Executive meeting/SoFi Comm., in polished alum w/soft glides for hard floor	151
126172-1	Five star foot base for HÅG H04/H05/Capisco/Capisco Puls in black aluminium	68
126172-2	Five star foot base for HÅG H04/H05/Capisco/Capisco Puls in silver aluminium	68
126172-3	Five star foot base for HÅG Capisco/Capisco Puls in white aluminium	68
126172-P	Five star foot base for HÅG H04/H05/Capisco/Capisco Puls in polished aluminium	141
126173-P	Five star foot base for HÅG SoFi/Futu/SoFi Comm. in polished aluminium	149
126176-1	Five star foot base for HÅG SoFi/Futu/SoFi Comm. in black aluminium	77
126176-2	Five star foot base for HÅG SoFi/Futu/SoFi Comm. in silver aluminium	77
126176-3	Five star foot base for HÅG SoFi/SoFi Comm. in white aluminium	77

Item no	Universal castors for soft floor/carpets and for hard floors (price per castor)	Price
125177	Universal castors, Ø65 mm, for soft and hard floors, black	5
125177-D	Universal castors, Ø65 mm, for soft and hard floors, grey	5

Item no	Castors for hard floors (price per castor)	Price
125108	Castors Ø50 mm, for hard floors, black	5

Item no	Castors for soft floor / carpets (price per castor)	Price
125104	Castors Ø50 mm, for soft floors, black	5
125178	Castors Ø65 mm, for soft floors, black	5

Item no	Glides (price per glide)	Price
125182	Universal glides for foot bases (task chairs)	3
113846	Carpet glides HÅG Conventio and HÅG Conventio Wing	1
113714	Carpet glides HÅG Futu 1070 with skid base	1
113927	Carpet glides HÅG Executive and HÅG SoFi Comm. with 4-star base	3

Item no	Felt glides for conference/visitor chairs (price per glide)	Price
125181	Felt glides for skid base for HÅG Futu 1070 with skid base	1
125186	Felt glides HÅG Conventio and HÅG Conventio Wing	1
125170	Felt glides HÅG H05 5370, 5470	1
125172	Felt glides HÅG H04 4470	1
125179	Felt glides (22 mm) for HÅG Executive meeting and HÅG SoFi Comm. with 4-star base	3

Item no	Armrests	Price
133537-1A	Armrests HÅG SoFi, adj. in black plastic with soft tops and stem in black painted alum.	133
133537-2D	Armrests HÅG SoFi, adj. in light grey plastic with soft tops and stem in silver painted alum.	133
133537-3D	Armrests HÅG SoFi, adj. in light grey plastic with soft tops and stem in white painted alum.	133
133537-PA	Armrests HÅG SoFi, adj. in black plastic with soft tops and stem in polished alum.	184
133538-1A	Armrests HÅG SoFi, adj. in black painted alum. with soft tops	156
133538-2D	Armrests HÅG SoFi, adj. in silver painted alum. with soft tops	156
133538-3D	Armrests HÅG SoFi, adj. in white painted alum. with soft tops	156
133538-PA	Armrests HÅG SoFi, adj. in polished alum. and with soft tops	212
133453-1A	Armrests HÅG Futu, adjustable black	48
133453-2A	Armrests HÅG Futu, adjustable silver	48
133547-1A	Armrests HÅG Executive task, HÅG TiltDown, black	279
133547-PA	Armrests HÅG Executive task, HÅG TiltDown, polished	279
133448-BB	Armrests HÅG Executive, task and meeting, basic, black	179
133299-1A	Armrests HÅG H05, adjustable, black	105
133299-2A	Armrests HÅG H05, adjustable, silver	105
133326-1A	Armrests HÅG H05 Comm. 5370, 5470, black	29
133330-1A	Armrests HÅG H04, adjustable black	80
133330-2A	Armrests HÅG H04, adjustable silver	80
133333-1A	Armrests HÅG H04 Comm. 4470 black	61
133333-2A	Armrests HÅG H04 Comm. 4470 silver	61
133322	Adjustable armrests for HÅG H03 , black	63
165232	Armrests HÅG Conventio, HÅG Conventio Wing, black	39

Item no	Headrest complete	①	②	③	④	⑤	⑥
134191	Headrest HÅG Tribute 9031	204	206	214	222	230	265
134188	Headrest HÅG SoFi 7200, 7300	193	196	202	210	217	252
134189	Headrest HÅG SoFi mesh 7500	193	196	202	210	217	252
134160	Headrest HÅG H05 5200, 5400, 5600	202	203	209	217	226	259
134161	Headrest HÅG H05 5100, 5300, 5500	182	184	190	197	204	234
134167	Headrest HÅG H04 4400, 4600, 4650	211	214	218	228	236	270
134172	Headrest HÅG Capisco 8106, 8107, 8126, 8127	151	151	156	162	172	181

Item no	Replaceable upholstery HÅG Futu	Price
108950-FTU001	Back FutuKnit - HÅG Futu 1070	44
108951-FTU001	Seat FutuKnit - HÅG Futu 1070	42
108943-FTU001	Back FutuKnit - HÅG Futu 1020	48
108944-FTU001	Seat FutuKnit - HÅG Futu 1020	42

Item no	Replaceable upholstery HÅG SoFi	①	②	③	④	⑤	⑥
108976	Seat HÅG SoFi	99	101	104	109	113	126
108977	Headrest HÅG SoFi	78	80	82	85	89	99
108974	Back HÅG SoFi 7300 (high)	88	90	93	96	100	112
108975	Back HÅG SoFi 7200 (medium)	83	85	87	91	94	105
108001	Lumbar pillow front, HÅG SoFi 750x (mesh)	8	8	8	8	9	9
108002	Lumbar pillow rear, HÅG SoFi 750x (mesh)	8	8	8	8	9	9

Item no	Replaceable upholstery HÅG Executive	①	②	③	④	⑤	⑥
108007	Headrest HÅG Tribute 9031	84	85	88	91	94	109
108781	Headrest HÅG Excellence and HÅG Inspiration	69	70	72	75	78	89
108779	Lumbar support HÅG Excellence and HÅG Inspiration	124	125	128	134	138	158
108005	Seat cover HÅG Tribute	91	94	111	130	152	167
108907	Seat HÅG Executive (all) prod. before 120317	89	90	93	96	100	115
108009	Seat, HÅG Excellence/Inspiration	87	90	106	124	145	158
146256	Seat, complete, HÅG Tribute	146	152	157	162	172	180
146257	Seat, complete, HÅG Excellence/Inspiration	139	145	149	155	164	172
111546	Back, complete, HÅG Tribute 9021, 9073	825	843	867	901	926	1 028
111547	Back, complete, HÅG Tribute 9031	912	930	958	995	1 023	1 135
108852-ATG56100	Back, HÅG Excellence 9321 and 9373 Paloma Soft						831
108853-ATG56100	Back, HÅG Excellence 9331 Paloma Soft						831
108912-SPA000	Back, HÅG Inspiration,Space textile for 9221,9273			163			
108913-SPA000	Back, HÅG Inspiration,Space textile for 9231			171			
108961-LUM100	Back, HÅG Inspiration,Lumina textile for 9221,9273			163			
108965-LUM100	Back, HÅG Inspiration,Lumina textile for 9231			171			

Item no	Replaceable upholstery HÅG Capisco	①	②	③	④	⑤	⑥
108769	Seat, HÅG Capisco 8105, 8106, 8107	103	106	109	113	117	131
108800	Seat, HÅG Capisco 8126, 8127	70	72	74	77	79	89
108803	Back, HÅG Capisco all models	96	98	101	105	109	122
108706	Headrest HÅG Capisco and HÅG H04	66	67	69	72	75	84

Item no	Replaceable upholstery HÅG Capisco Puls	①	②	③	④	⑤	⑥
108958	Pad, HÅG Capisco Puls, model 8001 and 8010	35	36	37	38	39	44
108959	Cushion, HÅG Capisco Puls, mod. 8002 and 8020			106	109		

Item no	Replaceable upholstery HÅG H05	①	②	③	④	⑤	⑥
111330	Headrest, HÅG H05 5100, 5300, 5500 (pillow+uph.)	94	95	99	102	108	113
108603	Headrest, HÅG H05 5200, 5400, 5600	66	67	68	72	77	85
108515	Back, HÅG H05 5200	86	87	90	93	99	109
108516	Back, HÅG H05 5400	87	88	90	94	100	111
108517	Back, HÅG H05 5600	88	89	91	95	101	112
108522	Seat, HÅG H05	54	55	57	59	62	69
108527	Back, HÅG H05 5100	84	85	87	90	95	107
108528	Back, HÅG H05 5300	130	131	135	140	149	165
108529	Back, HÅG H05 5500	130	131	135	140	149	165
108630	Back, HÅG H05 5370	130	131	135	140	149	165
108631	Seat, HÅG H05 5370, 5470	54	55	57	59	62	69
108632	Back, HÅG H05 5470	87	88	90	94	100	111

Item no	Replaceable upholstery HÅG H04	①	②	③	④	⑤	⑥
108706	Headrest HÅG Capisco and HÅG H04	66	67	69	72	75	84
108690	Back, HÅG H04 4400	89	90	92	96	102	114
108691	Back, HÅG H04 4600	91	92	95	99	105	116
108692	Back, HÅG H04 4100, 4200	88	89	91	95	101	112
108695	Back, HÅG H04 4650	98	99	102	106	112	125
108696	Back, HÅG H04 4470, 4472	82	84	87	90	95	105
108697	Seat, HÅG H04 4470, 4472	70	71	73	75	80	89
108869	Seat, HÅG H04 4100	64	67	69	71	75	85
108870	Seat, HÅG H04 4200, 4400, 4600	65	66	68	71	75	83
108871	Seat, HÅG H04 4650	67	68	70	73	78	86

Item no	Replaceable upholstery HÅG H03	①	②	③	④	⑤	⑥
108615	Back, HÅG H03 340	63	64	66	68	73	81
108619	Seat, HÅG H03 350	75	77	79	82	86	97
108620	Back, HÅG H03 330	44	46	48	49	52	57
108673	Seat, HÅG H03 330, 340	75	77	79	82	86	97

Item no	Replaceable upholstery HÅG Conventio	①	②	③	④	⑤	⑥
108391	Back, HÅG Conventio 9520	80	82	85	88	92	103
108946	Seat, HÅG Conventio 9520	80	82	85	88	92	103
108534	Back, HÅG Conventio 9521, 9522	89	90	92	96	102	113
108535	Seat, HÅG Conventio 9521, 9522	89	90	92	96	102	113
108728	Back, HÅG Conventio 9510	77	78	80	83	87	98
108729	Seat, HÅG Conventio 9510	77	78	80	83	87	98
108730	Back, HÅG Conventio 9511, 9512	88	89	91	95	101	112
108731	Seat, HÅG Conventio 9511, 9512	88	89	91	95	101	112

Item no	Replaceable upholstery HÅG Conventio Wing	①	②	③	④	⑤	⑥
108872	Back, HÅG Conventio Wing 9831, 9832	63	64	66	68	73	81
108873	Seat, HÅG Conventio Wing 9821, 9822, 9831, 9832	60	61	63	65	68	77

Item no	Miscellaneous	Price
149146	Disassembly tool for gas lift	50
149203	Disassembly tool for diverse (for removing back of HÅG H05 and the seats of HÅG H04/H05/Capisco)	16

Removable upholsteries are available for all HÅG chairs. Please contact Customer Service for support.

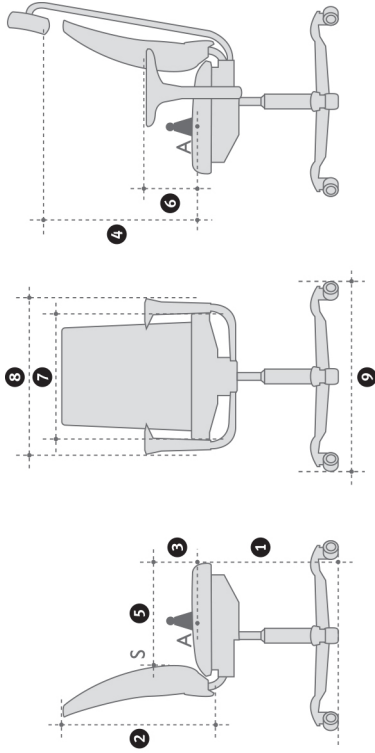

Physical measurements for HÅG working chairs

Measurements in mm. **A** mid-point of chair, loaded with 64 Kg. **S** foremost point of back pads, reference point for measurement of back support adjustment

Model	Seat height, measured with 64 kg load				3	4	5	6	7	8	9	Weight of chair in kg
	165 mm lift	200 mm lift*	265 mm lift	Height of back pads								
HÅG Sofi	Tilt range is 20° forwards and 14° backwards. The starting (neutral) position is taken as 4° backwards											
HÅG SoFi 7200	395-545	450-640	620	165-260	630-835	385-445	185-300	450	600-715	730	17,3	
HÅG SoFi 7300	395-545	450-640	720	165-260	630-835	385-445	185-300	450	600-715	730	17,5	
HÅG SoFi 7500	395-545	450-640	720	165-260	630-835	380-460	185-300	450	600-715	730	17,0	
HÅG Capisco	Tilt range is 15° backwards. The starting (neutral) position is taken as 2° backwards											
HÅG Capisco 8105	380-515	445-630	530-790			470		470		730	7.5	
HÅG Capisco 8106	408-540	470-655	555-810	460	150-240	340-420		470	595	730	14.0	
HÅG Capisco 8126	408-540	470-655	555-810	460	150-240	340-420		470	595	730	14.5	
HÅG Capisco 8107	408-540	470-655	555-810	460	150-240	340-420		470	595	730	15.5	
HÅG Capisco 8127	408-540	470-655	555-810	460	150-240	340-420		470	595	730	16.0	
HÅG Capisco Puls	Tilt range is 15° backwards. The starting (neutral) position is taken as 2° backwards											
HÅG Capisco Puls 8001	365-500	455-620	540-770			460		460		730	7.0	
HÅG Capisco Puls 8002	375-515	470-635	555-785			460		460		730	7.0	
HÅG Capisco Puls 8010	390-525	455-640	540-795	400	140-230	400-470		460	565	730	11.1	
HÅG Capisco Puls 8020	400-535	470-650	555-805	400	130-220	400-470		460	565	730	11.1	
HÅG Futu	Tilt range is 20° forwards and 14° backwards. The starting (neutral) position is taken as 4° backwards											
HÅG Futu 1020	400-550	450-640	580	160-255	195-290	385-465		470	610-700	730	16.8	

* According to EN1335 Class A
Please note that these measurements are not absolute. They may vary slightly from chair to chair.

Model	Seat height, measured with 64 kg load				2	3	4	5	6	7	8	9	
	165 mm lift	150 mm lift*	200 mm lift	265 mm lift									Height of back pads
HÅG Executive	Tilt range is 7° forwards and 18° backwards. The starting (neutral) position is taken as 3° backwards												
HÅG Tribute 9021	408-518		462-637		740	170-238		395-480	178-285	455	495-675	740	25.0
HÅG Tribute 9031	408-518		462-637		740	170-238		395-480	178-285	455	495-675	740	25.0
HÅG Inspiration 9221	405-535		455-645		780	165-255		395-480	200-300	455	495-675	740	20.0
HÅG Inspiration 9231	405-535		455-645		1060	165-255		395-480	200-300	455	495-675	740	21.5
HÅG Excellence 9321	405-535		455-645		780	165-255		395-480	200-300	455	495-675	740	19.5
HÅG Excellence 9331	405-535		455-645		1060	165-255		395-480	200-300	455	495-675	740	22.0
HÅG H05	Tilt range is 15° forwards and 16° backwards. The starting (neutral) position is taken as 1° backwards												
HÅG H05 5100	390-515		465-645	550-785	415	135-250	560-790	385-480	175-280	450	600-700	730	12.5
HÅG H05 5200	390-515		465-645	550-785	410	135-250	560-790	385-480	175-280	450	600-700	730	13.0
HÅG H05 5300	390-515		465-645	550-785	475	135-250	560-790	385-480	175-280	450	600-700	730	16.0
HÅG H05 5400	390-515		465-645	550-785	470	135-250	560-790	385-480	175-280	450	600-700	730	16.5
HÅG H05 5500	390-515		465-645	550-785	555	135-250	560-790	385-480	175-280	450	600-700	730	18.0
HÅG H05 5600	390-515		465-645	550-785	550	135-250	560-790	385-480	175-280	450	600-700	730	19.0
HÅG H04	Tilt range is 11° forwards and 16° backwards. The starting (neutral) position is taken as 4° backwards												
HÅG H04 4100	395-530		460-640	550-785	465	165-255	590-820	360-455	200-300	425	580-680	730	13.5
HÅG H04 4200	395-530		465-645	555-790	465	170-260	590-820	390-485	200-300	430	580-680	730	12.8
HÅG H04 4400	395-530		465-645	555-790	510	170-260	590-820	390-485	200-300	430	580-680	730	15.6
HÅG H04 4600	395-530		465-645	555-790	590	170-260	590-820	390-485	200-300	430	580-680	730	15.8
HÅG H04 4650	395-530		465-645	555-790	595	170-260	590-820	390-485	190-295	475	580-680	730	16.0
HÅG H03	Tilt range is 12° forwards and 10° backwards. The starting (neutral) position is taken as 0° backwards												
HÅG H03 330	412-551		520-700	548-783	300	170-240		400-470	165-285	420	630	686	12.0
HÅG H03 340	412-551		520-700	548-783	410	165-235		400-470	165-285	420	630	686	12.0
HÅG H03 350	412-551		520-700	548-783	430	160-230		400-470	165-285	445	630	686	13.0

* According to EN1335 Class A
Please note that these measurements are not absolute. They may vary slightly from chair to chair.

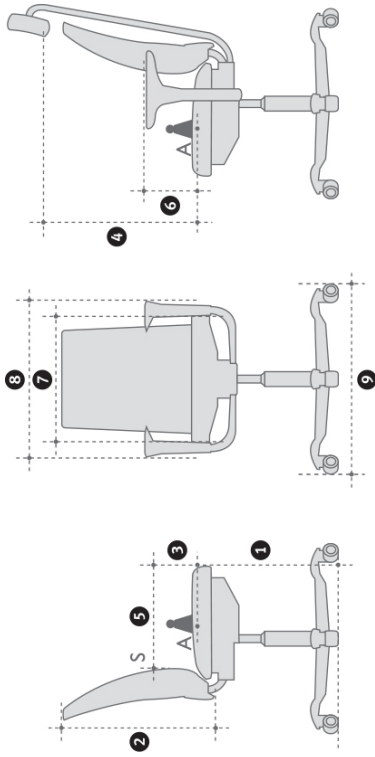

Physical measurements for HÅG meeting and conference chairs

All measurements in mm. Where a chair is adjustable, minimum and maximum measurements are listed.

Model	1 Seated height, measured with 64 kg load	2 Back height (mm)	3 Diam. footbase (mm)	4 Seat depth (mm)	5 Seat width (mm)	6 Chair width (mm)	7 Armrests (mm)	8 Weight (kg)	Tilt range		
									Neutral	Forwards	Backwards
HÅG SoFi Comm. 7202	400-550	620	785	380-460	450	600		16.2*	-2°	11°	13°
HÅG SoFi Comm. 7302	400-550	720	785	380-460	450	600		16.7*	-2°	11°	13°
HÅG SoFi Comm. 7502	400-550	720	785	380-460	450	600		15.7*	-2°	11°	13°
HÅG Futu Comm. 1070	465	460	-	460	465	550	215	9.3	-	-	-
HÅG Tribute meeting 9073	408-518	530	740	430	455	600-680 (740) 1)	155-265	19.2*	-4°	3°	13°
HÅG Inspiration Meeting 9273	385-520	570	650	440	455	600-680 (740) 1)	155-265	16.0 13.0*	-4°	4°	13°
HÅG Excellence Meeting 9373	385-520	570	650	435	455	600-680 (740) 1)	155-265	16.5 13.5*	-4°	4°	13°
HÅG H05 Comm. 5370	445	460	-	415	445	570 *470	235	7.2	-4°	9°	13°
HÅG H05 Comm. 5470	445	460	-	415	445	570 *470	235	7.2	-4°	9°	13°
HÅG H04 Comm. 4470	445	510	-	425	450	600 *480	210	10.2	-5°	9°	13°
HÅG H04 Comm. 4472	375-515	510	700	425	450	600 *480	210	9.1	-5°	9°	13°

1) Max. diagonal diameter

* Measurements without armrests

Please note that the measurements are not absolute. They may vary slightly from chair to chair.

Physical measurements for HÅG meeting and conference chairs

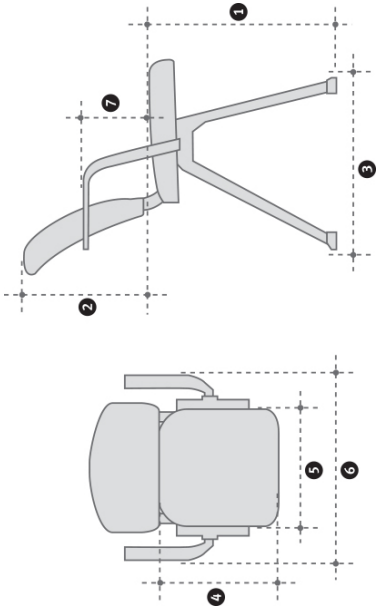

All measurements in mm. Where a chair is adjustable, minimum and maximum measurements are listed.

Model	1 Seated height, measured with 64 kg load	2 Back height (mm)	3 Diam. footbase (mm)	4 Seat depth (mm)	5 Seat width (mm)	6 Chair width (mm)	7 Armrests (mm)	8 Weight (kg)	Tilt range		
									Neutral	Forwards	Backwards
HÅG Conventio 9510, 9520	455	390	-	425	390	550 *460	230	5.0	-5°	12°	11°
HÅG Conventio 9511, 9521	450	460	-	430	430	590 *500	230	5.9	-5°	12°	11°
HÅG Conventio 9512, 9522	400-540	460	635	430	430	550 *460	230	8.3	-5°	12°	11°
HÅG Conventio Wing 9811/9841	430	380	-	420	430	600 *500	245	5.2 *4.4	-5°	12°	11°
HÅG Conventio Wing 9821	430	380	-	420	430	600 *500	245	5.4 *4.6	-5°	12°	11°
HÅG Conventio Wing 9831	430	380	-	420	430	600 *500	245	5.6 *4.8	-5°	12°	11°
HÅG Conventio Wing 9812	375-515	380	635	420	430	600 *465 (635) 1)	245	7.6 *6.8	-5°	12°	11°
HÅG Conventio Wing 9822	380-520	380	635	420	430	600 *465 (635) 1)	245	7.8 *7.0	-5°	12°	11°
HÅG Conventio Wing 9832	380-520	380	635	420	430	600 *465 (635) 1)	245	8.0 *7.2	-5°	12°	11°

1) Max. diagonal diameter

* Measurements without armrests

Please note that the measurements are not absolute. They may vary slightly from chair to chair.

Tests and Certificates

Environmental information	HAG SoFi	HAG Capisco 8106	HAG Capisco Puls	HAG Futu	HAG Inspiration 9231	HAG H05 5300	HAG H05 5370	HAG H04 4400	HAG H04 4470	HAG H03 320	HAG Conventio 9511	HAG Conventio Wing 9520
EPD (Environmental Product Declaration)	Yes	Yes	Yes	Yes	Yes	Yes	Yes	Yes	Yes	Yes	Yes	Yes
Environmental key indicators (from EPDs):	92	36	31	51	60	61	37	53	54	44	34	24
• Global warming (kg CO ₂ - equivalent)												
• Energy consumption (MJ)	1967	747	607	943	1370	1127	554	1021	900	786	396	397
• Amount of recycled material	45 %	43 %	48 %	33 %	46 %	37 %	34 %	39 %	21 %	32 %	29 %	26 %
• Amount of recyclable material	95 %	95 %	95 %	96 %	96 %	98 %	95 %	97 %	98 %	98 %	92 %	98 %
Nordic Eco Label (Swan)	Pending	Yes *									Yes	
GREENGUARD indoor climate certificate	Yes	Yes	Yes	Yes	Yes	Yes	Yes	Yes	Yes	Yes	Yes	Yes
ISO 1716 (calorific value)	Yes											

An EPD (Environmental Product Declaration) is a document that summarises a product's environmental performance. An EPD is based on a life cycle assessment (LCA). The requirements for how an EPD is determined are specified in the ISO 14025 standard. These standardised methods ensure that environmental information can be compared product by product, regardless of manufacturer, region or country. The GREENGUARD Indoor Air Quality Certification Program gives assurance that products designed for use in office environments and other indoor spaces meet strict chemical emissions limits, which contribute to the creation of healthier interiors.

* Chair upholstered in Fame

Tests and Certificates

Product tests	HAG SoFi	HAG SoFi Comm.	HAG Capisco	HAG Capisco Puls	HAG Futu	HAG Futu Comm.	HAG Executive	HAG Executive Meeting	HAG H05	HAG H05 Comm.	HAG H04	HAG H04 Comm.	HAG H03	HAG Conventio Wing	HAG Conventio	HAG Conventio Wing	HAG Tablet Arm
Ansi/Bifma (US)	Yes		Yes	Yes	Yes	Yes	Yes	Yes	Yes	Yes	Yes	Yes	Yes	Yes	Yes	Yes	Yes
EN 1335 Class A	Yes		Yes	Yes	Yes		Yes		Yes		Yes		Yes ¹				
EN 16139 (EN 13761)		Yes		Yes		Yes		Yes		Yes		Yes			Yes (Yes ¹)	(Yes ¹)	Yes
GS (DE)	Yes	Yes	Yes	Yes	Yes	Yes	Yes	Yes	Yes	Yes	Yes	Yes	Yes	Yes	Yes	Yes	Yes
BS 5459 (GB)	Yes *				Yes		Yes		Yes		Yes		Yes				
NPR 1813 (NL)	Yes w/3D armrest				Yes w/3D armrest				Yes		Yes						
EN 1729																	
Möbelfakta (SE)	Yes		Yes	Yes	Yes		Yes		Yes						Yes	Yes	
CAL TB 133			Yes	Yes											Yes	Yes	
CAL TB 117			Yes														

Certain assumptions have been taken. For more accurate information, please contact Customer Service Flokk.

¹ Without arm rests, () Model with star base, *) Q4, 2017

Flokk's quality and environmental directives are certified according to ISO 9001, ISO 14001 and EMAS.

HÅG Fast

HÅG Fast has been put together for you in order to make it easier to choose model, fabric and colour. In the table below you can see the HÅG Fast combinations. The HÅG Fast collection offers delivery from factory in only 5-10 working days after order has been registered.

Model	Fabric - Colour (code)										
	Xtreme Black EXR009	Xtreme Grey EXR081	Fame Black FM60999	Fame Grey FM60019	Nexus Black NEX13	Nexus Grey NEX001	FutuKnit Black FTU001	FutuKnit Grey FTU002	Note Black NT60999	Note Grey NT60088	Paloma Soft Black ATG 56100
HÅG H03 330	•		•	•							
HÅG H04 4200	•		•	•							
HÅG H04 4400	•		•	•							
HÅG H04 4600	•		•	•							
Headrest HÅG H04	•		•	•							
HÅG H05 5300	•		•	•							
HÅG H05 5500	•		•	•							
HÅG H05 5600	•		•	•							
Headrest HÅG H05 5300/5500, partly upholstered	•		•	•							
HÅG Futu 1020							•	•			
HÅG Capisco 8106	•	•	•	•							•
HÅG Capisco 8107	•	•	•	•							•
HÅG Capisco Puls 8010	•	•			•	•					
HÅG SoFi 7200	•	•	•		•	•			•	•	
HÅG SoFi 7300	•	•	•		•	•			•	•	
HÅG SoFi 7500	•	•	•		•	•			•	•	
Headrest HÅG SoFi	•	•	•		•	•			•	•	
HÅG Tribute 9021									•		•
HÅG Tribute 9031									•		•

• = Available in HÅG Fast

Please note; No cancellation or amendments are allowed for HÅG Fast.

In order to be able to provide this service to all customers, there is a limit of 10 chairs per customer per day. For orders over 10 chairs, please contact Customer Service for delivery details. Please specify that your order is HÅG Fast. During holidays we may not be able to deliver HÅG Fast within the specified time frame. For more information about holiday periods, please contact Customer Service, tel: 020 8683 9930, email: info-uk@flok.com

HÅG Total Colour Extended Collection

With minimum 5 year guarantee

If you cannot find what you are looking for in our HÅG Total Colour Standard collection, we offer a comprehensive range in our HÅG Total Colour Extended collection. We offer a 10 year guarantee on Xtreme, Fame, Capture, Sirdal og Suldal, Steelcut Trio 3, Nexus, Comfort+, Patina, Paloma and Vadal Uni. For more details on our guarantee please see page 4. Dispatch time from factory on Extended fabrics is usually 25 - 30 working days provided fabric is available from our suppliers stock.

Supplier / Collection

Bogesunds Väveri - www.bogesunds.se

	Price group
Breeze	5
Global ESD	Price on request
Liv	4
Rain	5

Bute - www.butefabrics.com

	Price group
Tweed	4

Camira Fabrics - www.camirafabrics.com

	Price group
24/7+	3
24/7 Flax	3
Blazer	3
Era	3
Hemp	3
Main Line Flax	3
Nexus (non standard)	4
Oxygen	3
Rivet	3
Sprint (non standard) only available on Puls and Wing	3
Patina	3
Synergy	3
Urban	3
X2	3
Xtreme (non standard)	3

Gabriel - www.gabriel.dk

	Price group
Breeze	3
Breeze Fusion	4
Capture	4
Comfort+ (non standard, not available for HÅG Tribute)	5
Crisp	3
Criss Cross	4
Elevation	3
Fame (non standard)	3
Gaja C2C	4
Gaja Classic	3
Interglobe Wool 2	3
Note (non standard)	4
Novo 2	3
Repetto	3
Step	3
Step Melange	3
Swing	4

GU - www.gu.no

	Price group
Amdal	4
Bardal	3
Gandal	4
Heidal	3
Hemsedal	5
Jostedal	3
Lodal	3
Modal	4
Modal Mouline	4
Modal Point	4
Setesdal	4
Sirdal (non standard)	4
Suldal (non standard)	4
Vadal	4
Vadal Uni (non standard)	4

Hornschuch - www.skai.com

	Price group
Etano	3
Evida (not available for HÅG Capisco Puls 8001, 8010)	3

Kvadrat - www.kvadrat.dk

	Price group
Canvas	4
Clara 2	3
Divina 3	5
Divina Melange 2	5
Divina MD	5
Fiord	4
Foss	4
Galaxy	5
Hallingdal 65	4
Molly 2	4
Pro 3	4
Remix 2 (Not available for HÅG Tribute)	4
Rime	4
Steelcut 2	4
Steelcut Trio 3 (non standard)	4
Tonus 4	4
Tonus Meadow	4

Ludvig Svensson - www.ludvigsvensson.com

	Price group
Balance	5
Brink	4
Era	4
Flex	4
Ink	4
Khaki	3
Moss	5
Raw	5
Rock	4
Step	4

HÅG Total Colour Extended Collection

Spradling - www.spradlingvinyl.eu

	Price group
Dolce	4
Valencia	3

Wollsdorf - www.wollsdorfleather.com

	Price group
Paloma	Price on request

Nevotex - www.nevotex.se

	Price group
Antistatic synthetic leather	3

Oniro - www.oniro.nl

	Price group
Puxx 1	3
Puxx 2	3

HÅG Colour and Fabrics

Decorative stitching

Decorative stitching can truly add the little extra to your chair.

The 10-colour thread program is available on all textiles for the following HÅG chairs:

HÅG Capisco model 8105, 8106 and 8107

HÅG SoFi collection

HÅG H05 model 5200, 5400, 5600 and headrest

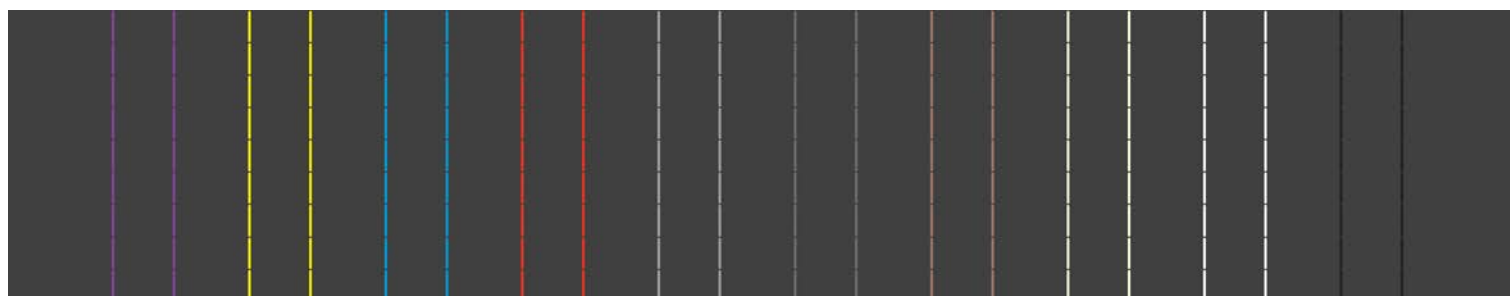

4908
Purple

1226
Yellow

6968
Turquoise

3822
Red

9389
Silver Grey

9582
Grey

8569
Beige

8135
Warm White

1712
Cold White

9700
Black

FutuKnit™ (Camira Fabrics)

FutuKnit is a fabric especially designed for the HÅG Futu, precisely shaped and fitted for the back support and seat cushion. The 3D knitted fabric adjusts itself to the curvature of the body. It provides higher seating comfort through soft upholstery with no foam and no unnecessary seams while maintaining good resilient elasticity. HÅG Futu 1020-F is only available in Futuknit. 8 colours listed below are available. HÅG Futu 1020 comes with FutuKnit on the backrest face, available in Grey (FTU002) or Black (FTU001) while the seat colour can be chosen from the HÅG Total Standard Colour program. For further information please contact your HÅG dealer.

Composition:	100% polyester
Abrasion:	> 110 000 Martindale
Flammability:	BS EN 1021 – 1-2: 2006 (Cigarette & match), BS7176: 2007 Low Hazard
Colour fastness to rubbing:	Dry and Wet 4 (scale 1–5)
Weight (g/m ²):	Cover. Model 1020. Back: 231 g Seat: 188 g Model 1070. Back: 184 g Seat: 176 g
Light fastness:	6 (scale 1–8)
Pilling:	5 (BS EN ISO 12945-2)
Environmental facts:	EU Ecolabel, Oeko-Tex® Standard 100, 100% free of heavy metals, ISO 14001 (company)

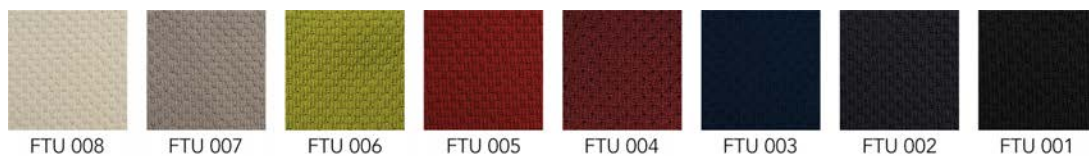

FTU 008

FTU 007

FTU 006

FTU 005

FTU 004

FTU 003

FTU 002

FTU 001

HÅG Capisco Puls Plastic Colours



HÅG Conventio Wing Plastic Colours



Sprint (Camira Fabrics) - Price group 3

Sprint is a classic stretch knit fabric made from 100% polyester. A smooth cellular construction with a subdued finish gives a minimalistic and light expression. **Sprint is only available for HÅG Capisco Puls & HÅG Conventio Wing.**

Composition:	100% polyester
Abrasion:	> 100 000 Martindale
Flammability:	BS EN 1021: 1&2 (Cigarette & match), BS 7176: 2007 Low Hazard, UNI 9176 Class 1 IM
Light fastness:	6 (ISO 105-B02)
Pilling:	4/5 (BS EN ISO 12945-2)
Environmental facts:	100% free of heavy metals, ISO 14001 certified (company)

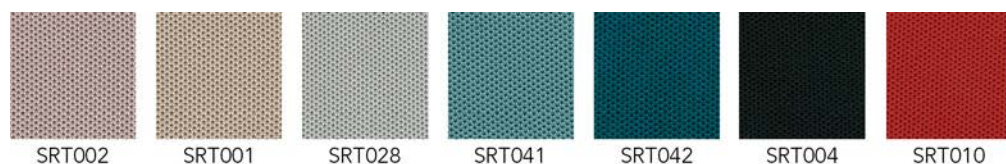

Mesh (Palmhive)

A warp knitted heavy duty mesh, using an innovative yarn construction to give increased strength which provides enhanced comfort, support and appearance. It's structure is soft and comforting with a semi-transparent effect. The mesh is available in black and light grey. Easy to combine with many fabrics and colours from the HTC collection. **Mesh by Palmhive is only available for the back of HÅG SoFi mesh.**

Composition:	100% polyester
Abrasion resistance:	150.000
Flammability:	BS EN 1021: 1 -2: 2014
Pilling:	4-5 (EN-ISO 12945-2)
Environmental facts:	Oeko-Tex® Standard 100



HÅG Total Colour Standard collection

– with 10 year guarantee as standard or 5 year guarantee on 24/7 use

HÅG Total Colour (HTC) Standard is our collection of fabrics, leather and other materials. The collection has been designed to bring out the best visual and functional qualities of these materials. All fabrics and leather in our Standard collection are of excellent quality. We offer short delivery times, a wide range and all our materials comply with strict environmental requirements.

Delivery time from factory is 15-20 working days after order has been registered. Transport days to be added.

Maintenance: Please vacuum with a furniture brush then use a clean cloth or sponge slightly dampened with clean lukewarm water.

Please note that colours shown in these illustrations may vary from the actual colours. Please contact your local HÅG supplier to view a sample.

Xtreme (Camira Fabrics) - Price group 1

Xtreme is a crêpe fabric made from 100% recycled polyester that features exceptional Euro flammability performance. Extra stretch and structure gives an irregular, shiny finish.

Composition:	100% recycled polyester
Abrasion resistance:	100 000 Martindale
Flammability:	BS EN 1021: 1–2 (Cigarette & match), BS 7176 Low & Medium Hazard, BS 5852 Section 4 Crib 5, DIN 4102 B1, UNI 9175 Class 1
Light fastness:	6 (ISO 105 - B02: 2013)
Pilling:	5 (BS EN ISO 12945-2)
Environmental facts:	EU Ecolabel, Oeko-Tex® Standard 100, 100% free of heavy metals

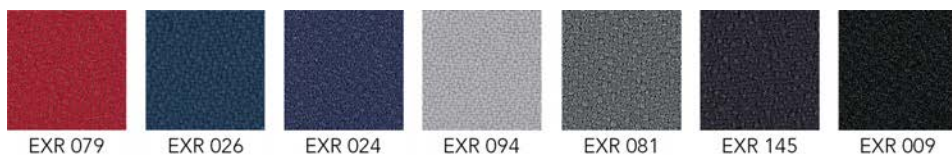

Fame (Gabriel) - Price group 2

Fame is a tightly woven fabric of worsted wool and polyamide, combining excellent durability and incredible softness.

Composition:	95% wool, 5% polyamide
Abrasion resistance:	200 000 Martindale
Flammability::	BS S EN 1021: 1–2, BS 5852, Crib 5, Calif. Bull. 117-2013, IMO MSC 307(88) Annex 1 part 8, NFP 92-503:M2 (Zirpro), ÖNORM B 3825-B1-3800-Q1 UK (Flován)
Light fastness:	5-7 (EN ISO 105 - B02)
Pilling:	4 (BS EN ISO 12945-2)
Environmental facts:	EU Ecolabel, Oeko-Tex® Standard 100, 100% free of heavy metals

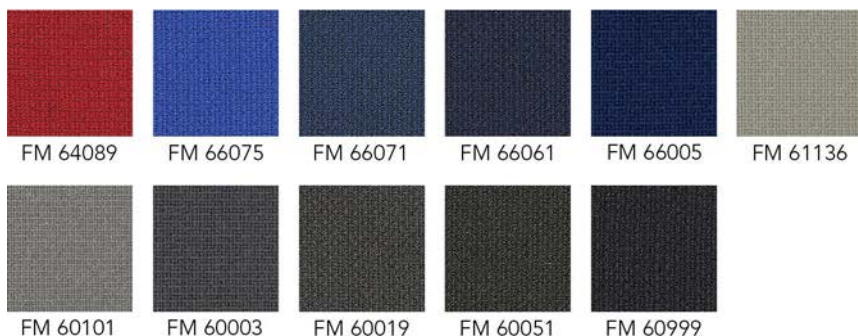

Capture (Gabriel) - PG 3

Capture is a lightly felted and multi-coloured wool fabric combining softness, stretch and strength. It fuses light and dark colours to a refined mélangé pattern in subtle nuances, which add richness and depth to the design.

Composition:	85% wool, 15% polyamide
Abrasion resistance:	200 000 Martindale
Flammability:	BS EN 1021: 1-2, BS 5852 Part 1 0,1 (Cigarette & match), Calif. Bull. 117-2013
Light fastness:	5-7 (EN ISO 105-B02)
Pilling:	4-5 (EN-ISO 12945-2)
Environmental facts:	EU Ecolabel, Oeko-Tex® Standard 100, 100% free of heavy metals

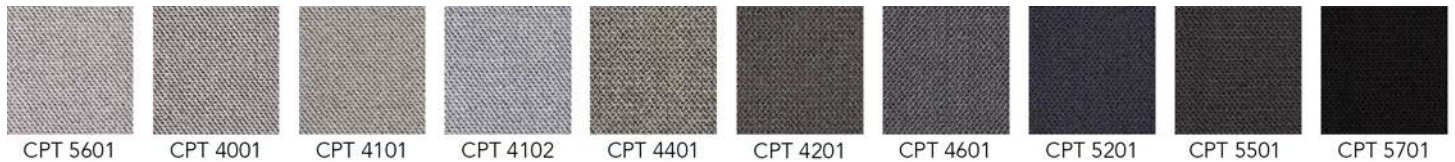

Nexus (Camira Fabrics) - Price group 3

Nexus is a polyester knit in a sleek and stylish pinprick dot matrix design effect giving a granulated structured surface. The black yarn foundation highlights the structured surface in combination with fresh but subtle colours.

Composition:	100% polyester
Abrasion resistance:	100 000 Martindale
Flammability:	BS EN 1021: 1-2 (Cigarette & match), BS 7176 Low Hazard
Light fastness:	5 (ISO 105 - B02: 2013)
Pilling:	4/5 (BS EN ISO 12945-2)
Environmental facts:	100% free of heavy metals, Manufacturing process - fully compliant with ISO 14001

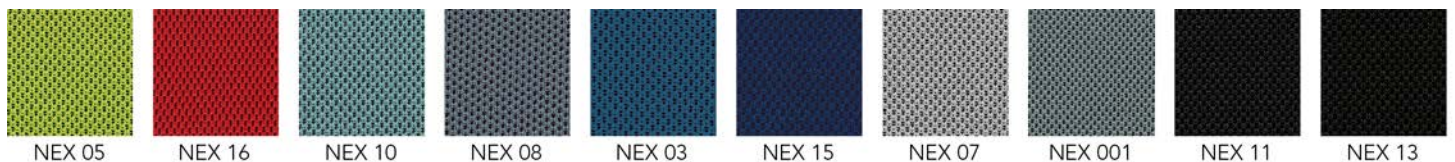

Note (Gabriel) - Price group 3

Note is a soft and noble fabric which, with its classic satin structure, allows the wool's natural lustre to shine and impress.

Composition:	85% worsted wool, 15% polyamide
Abrasion resistance:	200 000 Martindale
Flammability:	EN 1021 1&2, BS 5852 0&1, BS 5852 crib 5, IMO 307 (88) Annex 1 part 8, IMO MSC 307(88) Annex 1 part 8, Calif. Bull. 117-2013
Light fastness:	5-8
Pilling:	4 (BS EN ISO 12945-2)
Environmental facts:	EU Ecolabel, Oeko-Tex® Standard 100, 100% free of heavy metals, Manufacturing process - fully compliant with ISO 14001

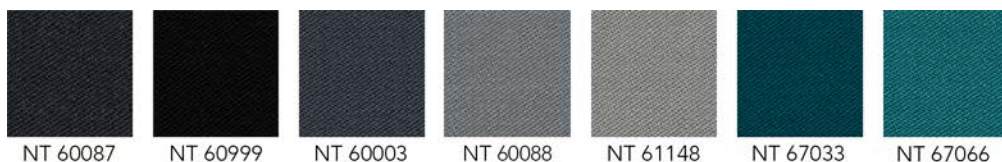

Patina (Camira) – PG 3

Patina has a high content of natural fibers, combining wool and flax for a delicate feel. Drawing inspiration from patterns in nature revealed to us by its fine structure and carefully balanced colours. It is about designing with nature to achieve beauty with performance.

Composition:	69% Wool, 22% Flax, 8% Polyamide, 1% Viscose
Abrasion resistance:	> 100 000 Martindale
Flammability:	BS EN 1021: 1–2, BS 7176, BS 5852
Light fastness:	5 (EN ISO 105-B02)
Environmental facts:	EU Ecolabel, 100% free of heavy metals

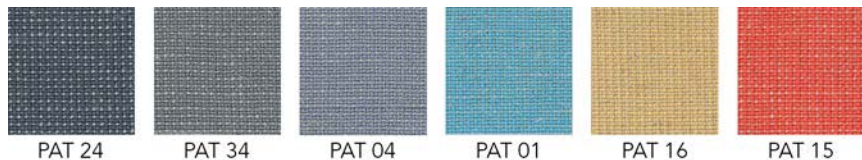

Steelcut Trio 3 (Kvadrat) - Price group 4

Steelcut Trio 3 is a strong worsted wool and polyamide woven fabric, made with three different coloured yarns. The colours and the special weave create a three-dimensional surface where the colours seem to change depending on the angle of perspective. (Not available for HÅG Capisco Puls).

Composition:	90% worsted new wool, 10% polyamide
Abrasion resistance:	100 000 Martindale
Flammability:	AS/NZS 3837, Class 2, BS 5852, ig. s. 2-3, DIN 4102 B2, ÖNORM B1/Q1, EN1021-1/2, IMO MSC 307(88) Annex 1 part 8, NF D 60 013, NFPA 260, UNI 9175, 1IM, Calif. Bull. 117-2013
Light fastness:	5–7 (ISO 1–8)
Pilling:	4 (BS EN ISO 12945-2)
Environmental facts:	EU Ecolabel



Comfort+ (Gabriel) - Price group 4

Comfort+ has a uniform stretchability and excellent non-pilling properties. A unique combination of fibres giving a durable soft surface. (Not available for HÅG Tribute).

Composition:	51% polyester, 37% recycled polyester, 12% polyurethane
Abrasion resistance:	150 000 Martindale
Flammability:	BS EN 1021: 1–2 (Cigarette & match), Calif. Bull. 117-2013, NFP 92-503:M3, ÖNORM B 3825-B2-3800-Q1 UK (Flován), UNI 9175 1IM, BS 5852 Part 1 0,1 (Cigarette & match)
Light fastness:	5-7 (EN ISO 105-B02)
Pilling:	5 (BS EN ISO 12945-2)
Environmental facts:	Oeko-Tex® Standard 100, 100% free of heavy metals

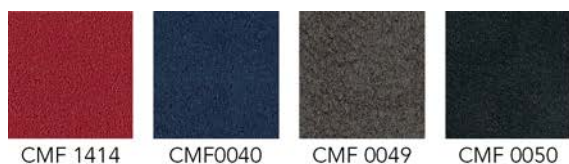

Shimmer (Innvik Sellgren) - Price group 4

Satin-woven worsted wool combined with polyamide. The weave and fibre combination yields an irregular, glittering effect.

Composition:	80% wool, 20% recycled polyester
Abrasion resistance:	104 000 Martindale
Flammability:	BS EN 1021: 1-2 (Cigarette & match)
Light fastness:	5-7
Pilling:	4-5
Environmental facts:	Manufacturing process – fully compliant with ISO 14001



SHI 099

Sirdal and Suldal (GU) - Price group 4

Sirdal and Suldal are part of the 100% Norwegian wool trio Sirdal, Suldal and Setesdal. These fabrics are uniquely short-travelled in every part of the process – 100% pure Norwegian wool manufactured in Norway.

Norwegian wool with its distinctive brilliance, resilience and durability is expressed through rich structures that evoke authenticity paired with chic and modern comfort.

Composition:	100% New Norwegian wool
Abrasion resistance:	> 57 000 Martindale
Flammability:	FTP code: Part 8 IMO MSC 307(88) Annex 1 part 8, EN ISO 12947-2:1999
Light fastness:	5-7
Pilling:	3-4 (BS EN ISO 12947-2)
Environmental facts:	Locally produced, 100% free of heavy metals



SRD 190



SUL 180



SUL 810



SRD 730

Vadal Uni (GU) - Price group 4

High quality, fine felted new wool fabric with an inviting appearance and a warm touch.

Composition:	92% new wool, 8% polyamide
Abrasion resistance:	102 000 Martindale
Flammability:	BS EN 1021: 1-2 (Cigarette & match), IMO MSC 307(88) Annex 1 part 8
Light fastness:	5-7
Pilling:	3-4 (BS EN ISO 12947-2)
Environmental facts:	EU Ecolabel, 100% free of heavy metals, Manufacturing process - fully compliant with ISO 14001



VAU 191

Paloma Soft (Wollsdorf) - Price group 6

High quality semi-aniline leather. All our standard colours from Paloma have a special finish adding a particular softness to the leather. Excellent friction and breathing properties. The surface may feature small scars and marks resulting from insect bites etc. These are proof of the natural origin of the product and are part of its character.

Flammability:	BS EN 1021: 1-2 (Cigarette & match), BS 5852 Crib 5, IMO MSC 307(88) Annex 1 part 8
Light fastness:	6 (EN ISO 105-B02)
Rubbing:	Wet 80/4 - Dry 1000/4 - Sweat 50/4 - ISO11640
Finish-adhesion:	≥ 2.5 N/CM - ISO 11644
Tear-strength:	≥ 20 N DIN EN ISO 3377-1
Environmental facts:	100% free of heavy metals, tanned without using chromium salts. BlueAngel, ECO ₂ L-certificate





Flokk is the market leader in the design, development and production of workplace furniture in Europe. We are the proud owner of product brands HÅG, RH, Giroflex, BMA, Offecct and RBM. About 700 employees work together to realize the vision of our company:

Inspire great work.

Our head office is in Oslo, Norway. We have production units in Røros (Norway), in Zwolle (the Netherlands), in Koblenz (Switzerland) and in Tibro and Nässjö (Sweden). In addition, we keep sales offices in Norway, Sweden, Denmark, Germany, Belgium, the Netherlands, UK, France, Switzerland, Singapore, USA, China and Australia. Flokk products are sold in more than 40 countries.

Flokk Ltd
Upper Tulse Hill Trading Estate
5 Somers Place, London, SW2 2AL
Tel: 020-8683 9930, Fax: 020-8683 9940
Email: info-uk@flokk.com
Web: www.hag-uk.co.uk | www.flokk.com

Showroom
63 Central Street, Clerkenwell,
London, EC1V 3AF